



sweepers & scrubbers

TERA

(33.TE.001 - Tera 1102) (33.TE.002 - Tera 1102R) (33.TE.003 - Tera 1303)



EN

INSTRUCTION AND MAINTENANCE HANDBOOK

01/2015 Rev.00



RCM S.p.A.
via Tiraboschi, 4 - 41043 Casinalbo - Modena - Italy
Tel. +39 059 515 311 - Fax +39 059 510 783
www.rcm.it - info@rcm.it

فرنام صنعت پاكسا
۰۲۱-۸۸۸۹۱۹۱۳



GENERAL INFORMATION

Scrubber identification data

Fig.1 Summary plate of the scrubber type

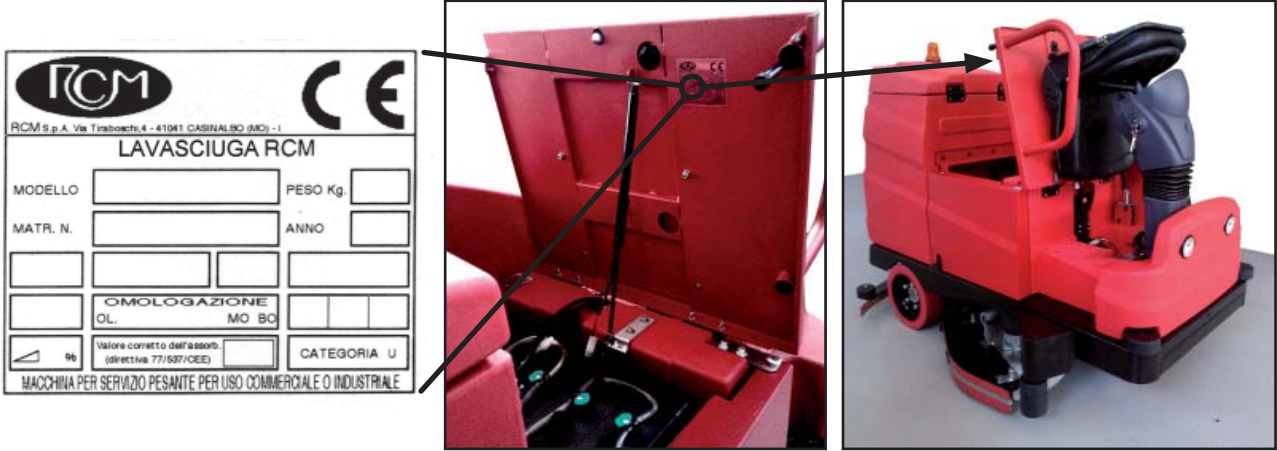

REQUESTS FOR ASSISTANCE

Any requests for assistance should be made after carefully analysing the problems and their causes, and you must indicate the following at the time of the call:

- » Hours of operation.
- » Serial number.
- » The details of the defects encountered.
- » The checks carried out.
- » The adjustments made and their effects.
- » Alarms displayed (in the case of electronic management).
- » Any errors of use.
- » Any other relevant information.

Direct requests to the authorised support network.

SPARE PARTS

When replacing parts, use only ORIGINAL SPARE PARTS, tested and approved by the manufacturer. Do not wait for components to become worn from use, replacing a component at the right time means better machine operation and savings as you avoid greater damage.

INDEX | PAGE

General Information	2
Request for assistance	2
Spare parts	2
Preliminary information	4
General safety standards	5
Standards to follow during operation	6
Maintenance standards	6
Technical data	7/9
Packaged machine handling	10
Components	11/13
Using the scrubber	14
Standards for scrubber commissioning	14
"STANDARD" operating mode	15
"Go GREEN" operating mode	16
"MY TERA" operating mode	16
"My Tera" accessory and parameter management dealer level (ENABLED)	17
Water Recycling (optional)	18
Vacuum spray (optional)	18
Water loading and draining	19
Detergent selection	19
Water filter cleaning (solution)	20
Disc brushes	20
> Replacing disc (washing) brushes	20
Roller brushes	21
> Replacing roller (washing) brushes	21
Squeegee	22
> Squeegee assembly/adjustment	22
Maintenance	23
> Cleaning the brushes and the squeegee	23
> Changing the drying edge replacing the rubber squeegee blades	23
Drive system	24
steering	24
braking	25
Vacuum motors	26
Battery	27
Battery installation	27
Electrical system	28
"Function board" alarms	28
"Traction inverter" alarms	29
Electric system wiring diagram	30/36
Periodic control, maintenance and safety checks	37
Control and maintenance operations table	37
Safety information	37
Machine demolition	37
Troubleshooting	38/39

PRELIMINARY INFORMATION

The following symbols are intended to attract the reader/user's attention so that the machine is used properly and safely, more precisely they mean the following:



Attention!

Highlights behavioural standards to be observed in order to avoid damaging the machine and the development of dangerous situations.



Danger!

Highlights the presence of dangers that cause residual risks the operator must pay attention to in order to avoid injury and/or damage to property.

Important!

This manual must be kept carefully. It should always be available for reference. In case of damage or loss, you can request a copy by contacting your dealer or the manufacturer directly.

We reserve the right to make changes to production, without being obliged to update previous manuals.

Before you start working with your SCRUBBER- DRIER, carefully read and understand the information contained in the manual and strictly adhere to the instructions given.

For maximum efficiency and durability of the machine, carefully follow the table indicating the periodic operations to carry out.

We wish to thank you for choosing one of our machines and we are at your complete disposal if you have any further needs.

Attention!

- 1) This machine is designed to be used solely as a scrubber-drier. Therefore, if used for any other purpose other than for what it has been designed, we assume no responsibility for any resulting damage. The risk is fully borne by the user. In particular, it cannot be used as a tractor or to transport people.
- 2) This scrubber-drier must be used to wash pavements, flat surfaces or inclines with varying gradients.
- 3) THE MANUFACTURER is not liable for any failure, breakdown, accidents, etc. due to a lack of knowledge (or non-application) of

the requirements contained in this manual. The same applies to modifications, variations, and/or the installation of accessories not authorised in advance. In particular THE MANUFACTURER declines all liability for damage caused by mishandling and lack of maintenance. Moreover, THE MANUFACTURER is not liable for actions taken by unauthorised personnel.

4) This machine is not suitable for vacuuming toxic and/or flammable substances, therefore, it is to be classified as category U.

5) The scrubber-drier must only be used by trained and authorised personnel.

6) Make sure that the machine remains stable when parked.

7) Keep people, especially children, at a safe distance during use.

8) For inspection and/or part replacement, the casing must be opened with the machine off. Make sure that:

» the motors are not running.

» the ignition key is removed.

9) The scrubber-drier, during transport, must be secured to the vehicle.

10) The batteries must only be charged in a covered and well-ventilated area.

11) Waste collected by the machine must be disposed of in compliance with the current national laws in force.



GENERAL SAFETY STANDARDS



The machine described in this manual is manufactured in compliance with the EU Directive 2006/42 /EC (Machinery Directive). It is the obligation of whoever is responsible for machine management to comply with the EU directives and national laws in force regarding the workplace, for worker health and safety. Before starting up, always perform the preliminary checks.



Attention!

The machine should only be used by a qualified operator. Do not allow the machine to be used by unauthorised personnel. Do not make modifications, changes, or applications on the machine that could compromise safety. Before starting up the machine, make sure that its operation does not put anyone in danger. Refrain from any manner of working that may affect the stability of the machine.

To transport the machine, make sure it is securely attached to the vehicle by means of the steering wheel and a wrap-around strap.

When working or during maintenance, it is mandatory to have appropriate protective equipment such as gloves, goggles, etc. in place.

To tow the machine, attach a hook to the eyebolt 1 (see photo)

To lift the machine, secure the lifting hooks 2 into the holes 3 located on the left and right of the frame and on the front eyebolt 3 (see photo).

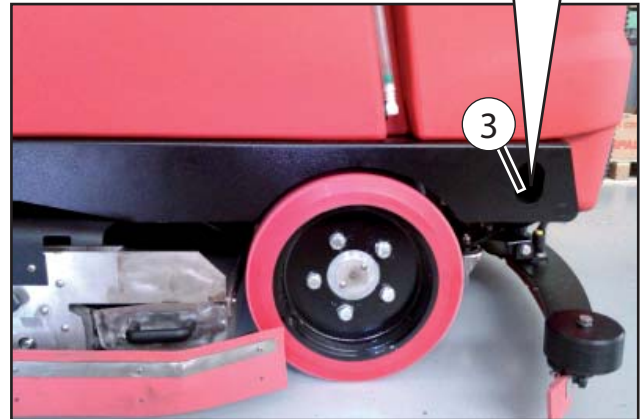

Danger!

In addition to the standards laid down by legislation, the person responsible for machine management must instruct operators on the following:

- » The fixed and/or movable guards including the casing and seat support must always remain in their housing, properly secured.
- » If, for any reason, such protections are removed, disengaged or short circuited, it is obligatory to restore them before starting the machine.
- » Use the machine only in technically perfect conditions and in accordance with its purpose.
- » Its intended use also includes observing all use and maintenance instructions, as well as the conditions for inspection and maintenance.
- » Vacuuming inflammable and/or toxic substances is strictly prohibited.
- » "Touching" the moving parts of the machine is absolutely prohibited; should it be absolutely necessary, first stop machine operation.
- » The casing should only be opened when the motors are not running, and the power is off. For battery-operated machines, the ignition key should be removed.
- » Using the machine in hazardous environments, in the presence of toxic vapours or fumes is prohibited, since the machine is not equipped with an enclosed cab.
- » Carrying passengers in addition to the operator is prohibited.



STANDARDS TO FOLLOW DURING OPERATION

Do not let persons who are not involved in the work approach the machine.

The machine is only to be used by operators authorised by the person responsible for machine management and who is familiar with the contents of this manual.

These operators must be physically and mentally fit, and not under the influence of alcohol or drugs or medications.

Ensure that:

There are no foreign objects on the machine (tools, rags, equipment, etc.).

The machine, after switching on, does not emit strange noises. Otherwise, stop it immediately, determine the cause and contact the technical support service.

All the safety guards are properly closed.

Refrain from any action which affects or raises any safety concerns.

Refrain from working in any way that undermines the stability of the machine, always keep a safe distance from the edges of pavements or uneven floors where the machine could fall.

Do not take slopes transversally and do not turn at excessive speed, especially if the floor is not horizontal.

Do not use the machine in dark places.

Be especially careful when approaching shelves or stacked objects (risk of collapse in the event of impact.)



Attention!

Do not use the vacuum system of the scrubber-drier without water. Using the vacuum without water is considered improper use and voids the warranty.

MAINTENANCE STANDARDS

During machine cleaning and maintenance or parts replacement, always turn the motors off and remove the ignition key.



Attention!

For any maintenance, revision or repair work, only employ qualified personnel or contact an authorised workshop.



Attention!

When you leave the machine, brake it in the parking position (TERA models with lever parking brake) or make the electric brake locks (TERA models with front in-wheel electric motor with brake), and remove the key.

Do not park the machine in prohibited areas (in front of doors, fire extinguishers or on an incline).



TECHNICAL DATA			
Versions	TERA 1102	TERA 1102R	TERA 1303
Performance			
Maximum hourly washing capacity	8800 m ² /h	8800 m ² /h	10400 m ² /h
Cleaning width	1100 mm	1100 mm	1300 mm
Drying width	1360 mm	1360 mm	1360 mm
Max. travel speed	9 km/h		
Max. reverse speed	4.5 km/h		
Max. working speed	8 km/h		
Max. gradient	16%		
Noise level (ISO 3746/95)			
Sound pressure level in operating position	dB(A) -		
Vibrations (ISO 2631/97)			
Level of the frequency-weighted accelerations	m ² /s -		
Brushes			
Brush (no.- type)	2 - disc	2 - roller	3 - disc
Position	Between front and rear wheels		
Turning speed (RPM)	160-170	840-880	160-170
Lifting	electric		
Diameter	560 mm	170 mm (front) 170 mm (rear)	490 mm
Pressure (weight)	0-115 kg	0-115 kg	0-90 kg
Waste container			
Capacity		30 L	
Squeegee			
Type	floating		
Vacuum (squeegee vacuum)	mm/H ₂ O 1500		
Lifting and lowering	electric		
Tanks			
Clean water (solution)	280 L		
Dirty water (recovery)	305 L		
Steering			
Type	with steering wheel/mechanics on front wheel		
Minimum space for U-turn	2550 mm		
Electric motors			
Drive motor	1 - 36 V - 2000 W		
Brush rotation motor	2 - 36 V - 500 W	2 - 36 V - 600 W	3 - 36 V - 500 W
Vacuum motor	2 - 36 V - 550 W		
Total power	4100 W	4300 W	4600 W
Batteries			
Battery (type)	equipped with automatic top-up and distilled water tank		
No./V/Ah	1 - 36 - 525		
Dimensions (length X width x height)	620 x 610 x 555 mm		
Peso Weight Poids Gewicht	603 kg		
Battery water	distilled water		
*Battery life (h)	4.40'	4.15'	4.10'
*Battery life may vary, depending on the type of battery and the use of the machine			

TECHNICAL DATA

Versions	TERA 1102	TERA 1102R	TERA 1303
Drive			
Position	front / forward and reverse drive with electronic control and drive selector		
Wheels			
Super-elastic front rubber wheel	Ø 375 mm		
Super-elastic rear rubber wheel	Ø 375 mm		
Brakes			
Position	on rear wheels		
Parking brake (type)	mechanical drum (TERA version with lever parking brake)		
Service brake (type)	hydraulic drum		
Electric brake	Electric on front wheel (TERA version with front in-wheel electric motor with brake)		
Dimensions (without brushes)			

(TERA 1102)



(TERA 1102R | 1303)



Machine weight

Weight when empty (without operator - without battery)	677 kg	672 kg	712 kg
Weight when empty (without operator - with battery)	1280 kg	1275 kg	1315 kg
Weight (without operator - with solution tank full and battery)	1560 kg	1555 kg	1595 kg

TECHNICAL DATA			
Versions	TERA 1102	TERA 1102R	TERA 1303
Instruments			
Display	√	√	√
Brush button	√	√	√
Brush pressure button	√	√	√
Vacuum motor button	√	√	√
H2O flow control button	√	√	√
ECO GREEN button	√	√	√
MY TERA button	√	√	√
Steering wheel switch controls*	*Speed-Reverse-horn		
Front work lights	√	√	√
Starter switch	√	√	√
Standard accessories			
Service brake	√	√	√
Parking brake ("TERA with lever parking brake" version)	√	√	√
Electric brake ("TERA with electric brake on front drive in-wheel electric motor" version)	√	√	√
Tilt angle and height adjustable steering wheel	√	√	√
Emergency flashing light	√	√	√
Accessories on request			
Rear-wheel drive	√	√	√
Sweeping system* :	√		√
* Brushing width	850 mm		850 mm
* Brush rotation (rpm)	600		600
* Brush diameter	170 mm		170 mm
* Brush motor	36V - 300W		36V - 300W
* Capacità cassetto rifiuti Waste container capacity	15 L		15 L
Sweeping side brushes (RH & LH)	RH	RH & LH	RH
Recycling	√	√	√
Detergent doser	√	√	√
H2O Spray Kit	√	√	√

PACKAGED MACHINE HANDLING

The machine comes packaged on a pallet.

The weight and dimensions are given in the TECHNICAL DATA.

The forks of the truck or the transpallet must be positioned so that the centre of the package is approximately at the centre of the forks themselves. The package must be handled with extreme care, avoiding impacts and lifting it to considerable heights.

Stacking the packages is prohibited.

Instructions for machine unpackaging

The machine must be unpackaged carefully and gently, removing the brackets on the wheels. At this point, the machine must be brought to ground level by means of a metal or wooden ramp.

Unpackaged machine handling

The unpacked machine must be checked and the batteries must be assembled if not already installed.

Should it need to be handled after use for short distance transportation, disconnect the battery cables, remove the brushes and squeegee. Make sure the parking brake is disengaged (for TERA models with lever parking brake) or the electric brake is unlocked by using the release key (for TERA models with front in-wheel electric motor and electric brake).

For very long distance transportation, it is a good idea to repackage the machine in the original box on a pallet. Please note that the machine can be pushed to move it short stretches.

Lifting the machine

For lifting, the operation must be done with approved equipment with suitable capacity.

Transporting the machine

Whenever the machine has to be transported, it is **IMPORTANT** to:

- 1) Verify that the solution tanks (clean water) and recovery tanks (dirty water) are empty.
- 2) Lift the brushes and the squeegee.
- 3) Brake the scrubber-drier in the parking position (TERA versions equipped with lever parking brake)
- 4) Ensure the electric brake of the scrubber-drier is engaged (TERA versions equipped with front in-wheel electric motor with electric brake)
- 5) Secure the machine to the transport vehicle using special straps.
- 6) Remove the brushes.
- 7) Disassemble the squeegee.
- 8) Disconnect the battery.
- 9) Cover the machine in the event of an uncovered transport vehicle.



COMPONENTS

1. Brush control button and "rear sweeping unit/side brushes - optional".

By pressing button 1 (with a "short" first push), the washing brushes switch on. A second "prolonged" push activates the rear sweeping unit / side brushes (if any). The same button lowers and raises the brushes. To deactivate all brushes, use a "short" push on the button and release it. To deactivate the sweeping unit/side brushes, use a "prolonged" push on the same button and release it.

The function is shown on the display with the symbol .

2. "GO GREEN" button

Pressing the button will activate and automatically adjust all functions, brushes, vacuum (See the "GO GREEN" WORKING MODE chapter). The function is shown on the display with the symbol .

3. Vacuum and squeegee control button

Controls the switching on and off of the vacuum motors.

The same button lifts and lowers the squeegee.

The function is shown on the display with the symbol .

4. "MY-TERA" button

This function allows you to establish and set the operating parameters relative to the quantity of water, detergent (only with Detersaver) and brush pressure (See the "MY-TERA" WORKING MODE chapter).

The function is shown on the display with the information *My.*

5. "Optional" water recycling button

When the solution runs out, pressing the button enables you to REUSE the water (with detergent still active) collected by the squeegee, thus avoiding having to stop to refill the solution tank with water.

The function is shown on the display with the symbol .

6. "Optional" washing and drying spray button



Attention!

Before using the spray, check the clean water tank and refill it if necessary.

Pressing button 5 enables the function, the washing and drying spray is ready to be used. The function is shown on the display with the symbol .

7. Water flow control button

By pressing button 7, you can adjust the flow of water on the washing brushes (See the OPERATION IN "STANDARD" MODE chapter). The function is shown on the display with the symbol .

8. "DETERSAVER" button (optional)

By pressing button 8, you choose the desired dilution program, keeping the % of detergent proportional to the quantity of water requested.

Detergent program:

- 1st program > dilution at 1%
- 2nd program > dilution at 2%
- 3rd program > dilution at 4%

The function is shown on the display with the symbol .

9. Brush pressure adjustment button

By pressing button 9, you can adjust the pressure of the brushes on the floor. (See the "STANDARD" OPERATING MODE chapter).

The pressure setting is shown on the display with the symbol .

10. Starter switch

Controls engagement of the general system.

(See "RULES FOR THE OPERATION OF THE SCRUBBERS - point 5").



11. Steering column switch

Sets the speed of the machine, forward or reverse drive and the horn.

- » Turning the switch (as shown in the figure) to gear "I" sets the first speed.
- » Turning the switch to gear "II" sets the second speed.
- » Turning the switch to gear "III" sets the third speed. (see the "STANDARD" OPERATING MODE chapter).

To move the machine forward, lift the switch from the neutral position ("N") and move it forward (A).

To reverse the machine, lift the switch from the neutral position ("N") and move it back (R).

Pressing "C" activates the horn.

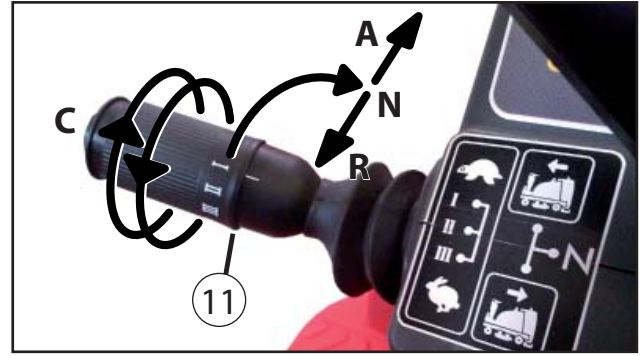

12. Brake pedal (hydraulic)

Controls machine braking.

(also refer to the "Braking" chapter).

13. Lever parking brake (mechanical) with safety micro-switch.

(TERA models fitted with lever parking brake)

By using the lever, it is possible to brake the machine in the parking position. The brake is equipped with a safety microswitch which prevents the machine from being operated when the parking brake is engaged. (also refer to the "Braking" chapter).

Braking is indicated on the display by the parking symbol followed by an acoustic signal. (P)



! Attention!

engage the parking brake when parking on an inclined surface.

14. Forward pedal (electric)

Controls the forward or reverse movement of the machine.

Before pressing the pedal, set the machine speed and the drive direction via the steering column switch pos.11.



15. Battery connection plug

(See the "electrical system" chapter)

16. Steering wheel adjustment lever

By releasing the lever, you can tilt the steering wheel forward or backward, lower it or raise it. Once adjusted, relock the lever.



17. Display

When the machine is switched on, the display temporarily shows the following information:

1st screen:

» Machine name

2nd screen:

» Machine model
» Software version
» Type of battery installed
» Total and partial hour meter

3rd screen:

After the information described above, the display will show the symbols as described below.

(Refer also to the "SWITCHING ON THE MACHINE" chapter).



Indicates the adjustment level of the water flow on the brushes. (see "button 7").



Detersaver "Option". Indicates the percentage of detergent on the brushes (see "button 8").



Indicates the pressure of the brushes on the floor. (see "button 9").



The battery symbol indicates the battery charge status.

When the battery is low, the brushes are disabled to allow the drying phase to be completed and the machine to be transferred to the charging area.

When the battery dies, the washing, vacuum and transfer system functions are disabled in succession.

18. Solution tank (clean water)

At every wash, open outlet "A" to fill or top-up the tank with water and detergent.

19. Recovery tank (dirty water)

Contains the dirty water which, from the washing brushes, is vacuumed by the squeegee. At the end of each wash, drain the dirty water from the tank and clean it (see "water loading-draining" paragraph).

20. Brush base

The disc or roller brushes fitted on the base are used to wash the floor. (see the "BRUSHES" chapter).

21. Squeegee

The squeegee vacuums the dirty water coming from the brushes. (see the "SQUEEGEE" chapter).

22. Electric brake

(TERA models equipped with front drive in-wheel electric motor **WITH** electric brake)

See the "Braking" chapter.

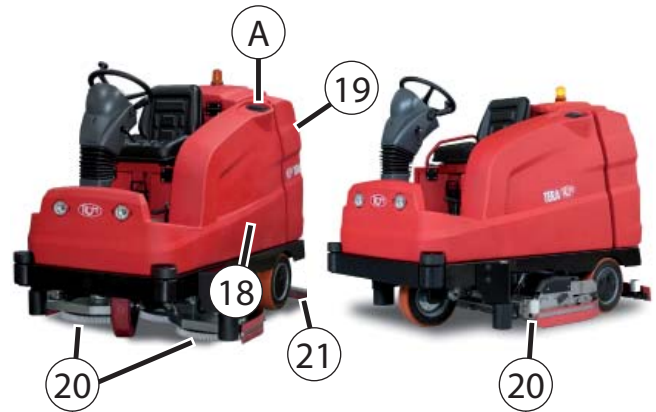

Tera: spazzole a disco | disc brush | cepillo de disco | brosse à disque | Scheibenbürste | Schijfborstel

Tera: spazzole a rulli | Roller brush | cepillo de rullo | brosse à rouleau | Rollenbürste | Rolborstel

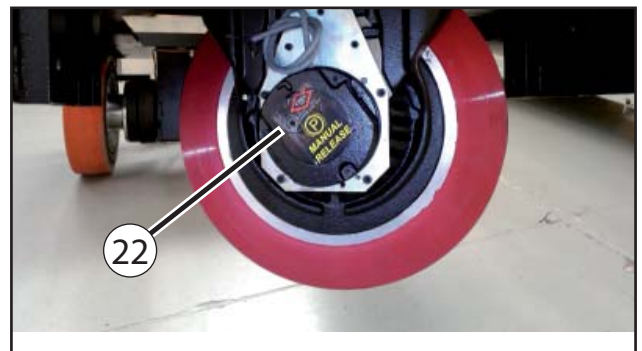

USING THE SCRUBBER

Necessary precautions

1. The scrubber should only be used by competent and responsible persons.
2. When you leave the scrubber unattended, you must remove the key (see "COMPONENTS" POS.10) and stop it by using the parking brake lever (see "COMPONENTS" POS.13).
3. Do not park in restricted areas, in front of doors, fire extinguishers, on inclines, etc.
4. When the scrubber is stopped, the brushes should be raised to avoid deforming the bristles.
5. Do not stop the machine on an incline.
6. If the machine is used in dark places, use the lighting system.
7. Do not use the machine on uneven or slippery surfaces or in the vicinity of unprotected gradients where there is a risk of overturning.
8. Carrying passengers in addition to the driver is prohibited.
9. Using the machine in hazardous environments with the presence of toxic vapours or fumes etc. is prohibited, since the machine is not equipped with an enclosed cab.
10. Use extreme caution when approaching shelving or stacked objects.



Attention!

Before using the scrubber, check the liquid level in the battery.

STANDARDS FOR SCRUBBER COMMISSIONING

Points for scrubber commissioning.

1. Make sure the water (see "COMPONENTS" POS.19) recovery tank is empty.
2. Fill the tank with clean water (see "COMPONENTS" POS.18)
3. Make sure that the brushes are lifted off the ground. (see "COMPONENTS" POS.3)
4. In the TERA model equipped with a parking brake make sure that the lever for that brake is released. (see "COMPONENTS" POS.13)
5. Insert the key (see "COMPONENTS" POS.10) in the main panel and turn it clockwise (this operation will power the general control equipment). (See also the "SWITCHING ON THE MACHINE" chapter)
 - » Pos. 0 = Machine off
 - » Pos. I = Machine on
 - » Pos. Lights symbol = Machine and front lights on.
6. Proceed as described in the OPERATION IN "STANDARD" MODE chapter.



Attention!

The only scrubber works if the operator is properly seated in the driver seat.





“STANDARD” OPERATING MODE

Switching on the machine

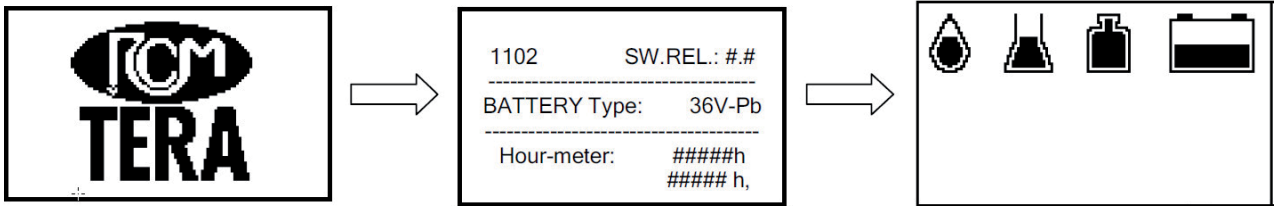
When the electrical system is switched on via the ignition key on position 1 (see "COMPONENTS - POS.10"), the logo appears, then the display shows the machine type, the software version, the battery voltage and the hour meter. Then another screen appears, relative to the system status with the battery charge, the various active functions and their settings and any alarms.



After the above sequence has finished, the display will show the status of the clean water tank (solution). If it is empty, the symbol  will appear, see to refill it. If, on the other hand, it is full, the display will show the symbol .

Before carrying out the washing operation, proceed as follows:

- » Via the steering column switch described in the "COMPONENTS - POS. 11" chapter, set the speed and the travel direction of the scrubber-drier as follows:

Gears:

- Select gear "I" for a thorough wash or
- Select gear "II" for a medium wash or
- Select gear "III" for a fast wash.

- » Rotate and lower the brushes using button "1"., adjust the pressure of the brushes on the floor by pressing button "2" then proceed as follows:

The function has three settings, minimum/medium/maximum. The display shows THE SYMBOL with the selected pressure increment.

- » Press the button once to set a minimum brush load.
- » Press again to set a medium brush load.
- » Press a third time to set a maximum brush load.

The pressure thus set will be automatically maintained.

- » Open and adjust the washing water:

Press button "3" to activate the function and adjust the washing water flow on the brushes. The function provides for the adjustment of the flow from fully closed to fully open.

The water adjustment thus set will be automatically maintained.

We recommend using an intermediate amount of water so that the entire surface immediately after the brushes is well wet, without an excess of water creating spraying, trickling or overflowing of the squeegee.

- » Engage the vacuum motors using button "4".
- The squeegee automatically lowers to vacuum the water.

Attention: the squeegee lowers only if the forward travel direction was selected beforehand via the steering column switch on position "A" (see COMPONENTS - POS.11) .

- » Press the forward pedal (see "COMPONENTS" POS.14) so that the machine advances at the desired speed and direction, starting the washing operation.

Should you wish to reverse during the washing and drying phase, change the direction of travel via the steering column switch (see "COMPONENTS" POS.11) on the "R" position, causing the squeegee lift automatically.

When the washing and drying is finished, proceed as follows:

- » Stop the rotation of the brushes by pressing button "1". The brushes lift automatically, the water flow is interrupted.
- » Stop the vacuum by pressing button "4". The squeegee lifts automatically.

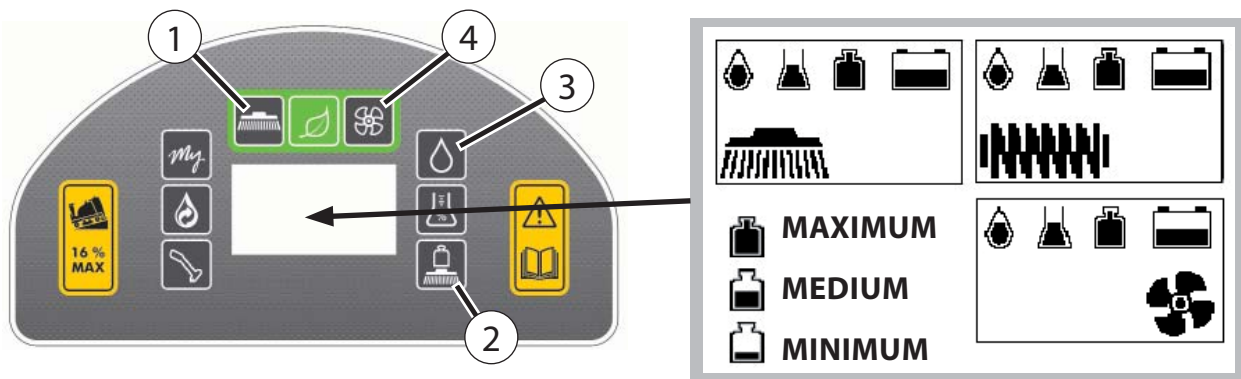



"GO GREEN" OPERATING MODE



This mode enables you to reduce water, detergent and energy consumption.

To activate "GO GREEN" mode, simply press the button  for about 1 second. The operator will immediately be able to carry out the washing phase without making adjustments to the functions such as brushes, water flow opening, vacuum and squeegee. The said functions are regulated automatically by activating this mode. The function is shown on the display with the symbol.

To switch from "GO GREEN" operating mode to "standard" mode, press the button  for about 3 seconds. The display shows the symbols, brushes and vacuum like in "standard" mode. 

To reactivate "GO GREEN" operating mode, press the button  for about 1 second.

To deactivate "GO GREEN" operating mode, press the button  for about 1 second.

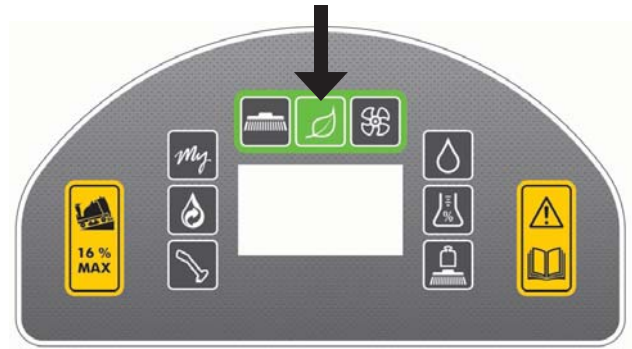

"MY TERA" OPERATING MODE



With this mode, you can establish and set the operating parameters relating to the amount of water, detergent (only with the "Detersaver" option function) and brush pressure.



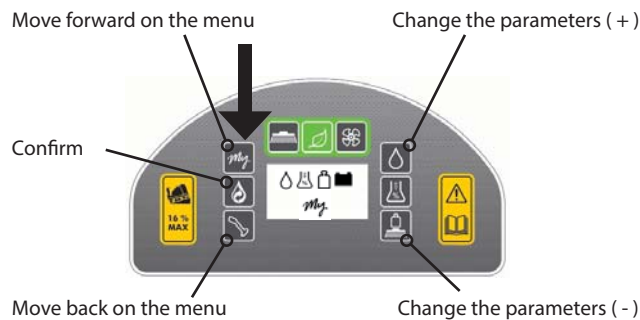

To activate "MY TERA" mode, press the button . The operator will immediately be able to carry out the washing phase using the configuration pre-set by the manufacturer or "qualified and authorised" dealer or the operator himself can create a custom one (if enabled) to fit his needs. There are two setting management levels on the electronic control, each protected by a password.

- 1st Level "USER" (if enabled)
- 2nd Level "DEALER" (if enabled)



To manage the programming on the electronic control, some commands have a dual function as shown in the following image:



To access the parameter edit program (**qualified operators and dealers**), proceed as follows:

- » With the machine off, press the buttons  and , then turn the ignition key from 0 to 1 (see COMPONENTS POS.10).
- » With the  button, search for "enter password".
- » Enter the password pressing the button 
- » Confirm password pressing the button 

When the first symbol on the display switches on and flashes (for example, the one related to the water flow), this indicates that it can be set. Proceed by entering or changing the parameters related to the symbol, using the buttons described in the paragraph below. Once the settings of the first symbol are confirmed, a second symbol will start to flash, and so on. To enter or change the parameters, proceed as follows:

- » Press the  button to enter the value
- » Press the  button to confirm the value

Once the parameters are entered, "MY" flashes on the display.
 Confirming "Fixed" = only activates "MY" mode.
 Confirming "Enable" = activates "MY" mode and STANDARD mode.



The next page describes "accessory management" and "changing parameters" **ONLY** for "DEALER LEVEL" dealers.

ACCESSORY MANAGEMENT AND "MY TERA" PARAMETERS | DEALER LEVEL (ENABLED)

The following table shows the main settings; to edit them, you must set the password to the "DEALER PASSWORD" setting. Without confirming it with the "CONFIRM" button, scroll down to the desired parameter and change it.

Main settings	default	minimum	maximum
» Model selection. (Machine type).	TERA 1102 - TERA 1102R - TERA 1303		
» "DETERSAVER" function (optional). (Adjusts the quantity of detergent and water separately).	NO	NO	YES
» "SPRAY & VACUUM DEVICE" (optional) function.	NO	NO	YES
» "WATER RECYCLING" function (optional).	NO	NO	YES
» "REAR SWEEPING DEVICE" function (optional) (operation of the machine in sweeping mode).	NO	NO	YES
» "SIDE BRUSH" function (optional) (sweeping or washing mode).	NO	sweeper	scrubber-drier

With the same password, the DEALER can change the following parameters:

» Reset hour meter (Reset the "partial" hour meter)	NO	NO	YES
» Battery type (Change the battery type, display the voltage)	36V-Pb	36V-Gel	36V-AGM
» Alarm language (Alarm display language)	ENG (English)	ENG (English)	ITA (Italian)
» Display contrast (from 5 to 20) (Adjusts the display contrast)	15	5	20
» Display brightness (from 0 to 20) (Adjusts the display brightness)	10	0	10
» Brush switch off delay (from 0 to 10 sec.) (Adjusts the switch off delay of the brushes)	0.2	0.0	10.0
» Vacuum switch off delay (from 0 to 30 sec.) (Adjusts the switch off delay of the vacuum motors)	5	0	30
» Service (h)  (Used to activate the request for assistance after a certain established period 'expressed in hours), the symbol flashes on the display for about 10 seconds. This display will reappear each time the machine is switched on until the hour counter is reset. (THIS DISPLAY REQUESTS ROUTINE MAINTENANCE AT AN AUTHORISED WORKSHOP).	NO	20	1000
» Enter password (To access the modifiable parameters, depending on its value, you can access the following sub-menus): - DEALER password: For support service (SET IT BUT DO NOT CONFIRM IT) - Password  : To set the parameters of the "MY" function. (SET IT AND CONFIRM IT).	0	0	9999

WATER RECYCLING (OPTIONAL)

To enable this function, just press the button indicated by the arrow. When the solution in the tank runs out, the function allows you to use the water (with detergent still active) collected by the squeegee, avoiding stops to fill the tank, as shown in the figure.



VACUUM SPRAY (OPTIONAL)

To activate this function, just press the button indicated by the arrow. The function stops the brush motors and lifts the squeegee, allowing you to use the spray for a finishing clean.

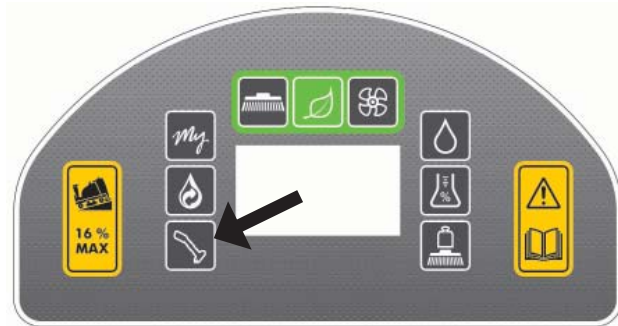

WATER LOADING AND DRAINING

Before each wash, fill solution tank 1 with the right amount of detergent and water by opening cover 2.

The tank is built in polyethylene, which is resistant to acids and alkalis as well as most solvents.

After washing, drain the dirty water from recovery tank 3 through pipe 4. To facilitate draining the water and debris, the recovery tank can be tipped over (as shown in the photo).

Thoroughly clean the recovery tank by opening drain outlet 5, check the cleanliness of vacuum filter 6 and waste collection container 7.

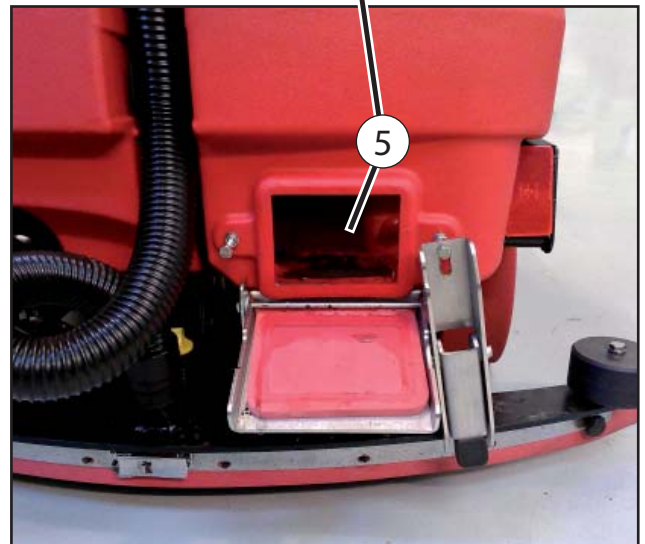
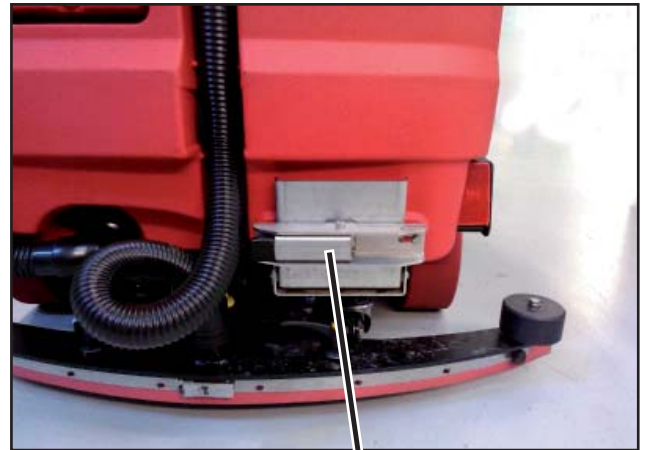

Detergent selection

To clean the floor well, it is necessary to find the right detergent. Use low hazard detergents, wash your hands after handling them. Refer to the instructions contained in the safety data sheets of the detergent. If necessary, seek advice from the supplier or a competent person, bearing in mind that a detergent that is too harsh can be harmful for the service life of the machine.

It is necessary to use low foam detergent, or anti-foam additive to prevent damage to the vacuum motor. If you cannot find such products, to avoid foam, you can use ordinary wine vinegar, pouring 50cc in the solution tank before washing.

WATER FILTER CLEANING (SOLUTION)

To maintain an efficient filter system, it is necessary to clean the solution filter 1 once a month.

To clean the filter, do the following:

- » Unscrew filter element 2 from filter body 3.
- » Remove filter cartridge 4.
- » Clean the filter cartridge with a brush and use a jet of air to remove any remaining impurities.
- » Finally, wash the cartridge and insert it into the filter element and screw it back onto the filter body.

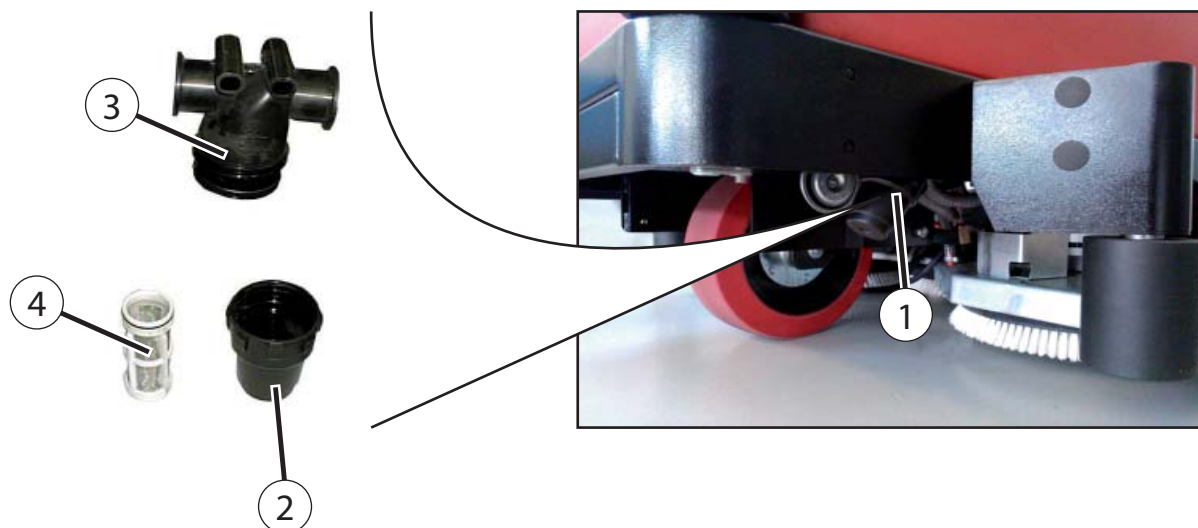

DISC BRUSHES

Replacing disc (washing) brushes

Before proceeding with brush replacement, remove the key from the ignition panel, thus preventing any motors from accidentally switching on, then proceed as follows:

- » Open protection 1 of the brush to the right and left of the machine by releasing lever 2 from locking pin 3.
- }» Open spring clip 4 on the drive disc, like in the picture, to release the brush from its support.
- » Remove the drive disc from the old brush and fit it on the new one.
- » Install the new brush by wedging it into its support.
- » Close the protection again by reattaching the lever to the locking pin.

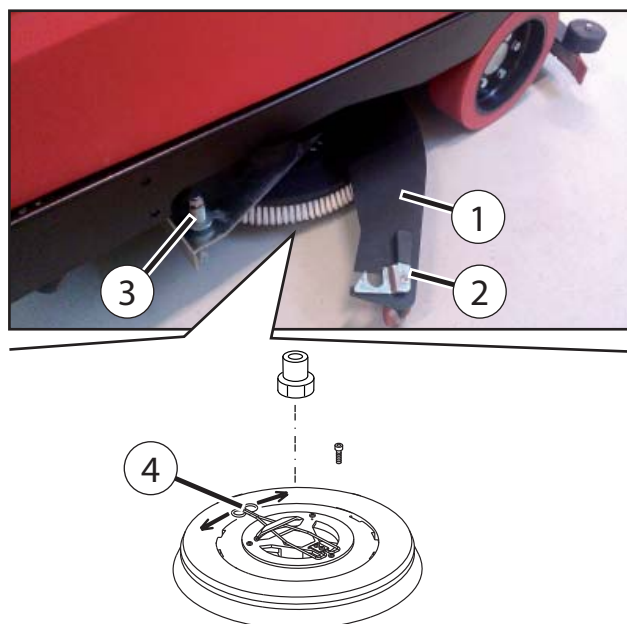

ROLLER BRUSHES

Replacing roller (washing) brushes

Remove the ignition key and proceed as follows:

1. Pull up left side lever 1 of the brush base to release flap 2.
2. Turn brush support 3 clockwise to the slot end.
3. Remove support 3 from the base and remove brush 4 on the left side (A) as shown in the photo.
4. Install the new brush by repeating the operations in reverse order.

To replace the brush on the right side (B) proceed as described in points 1) 2) 3) 4) for the left brush.

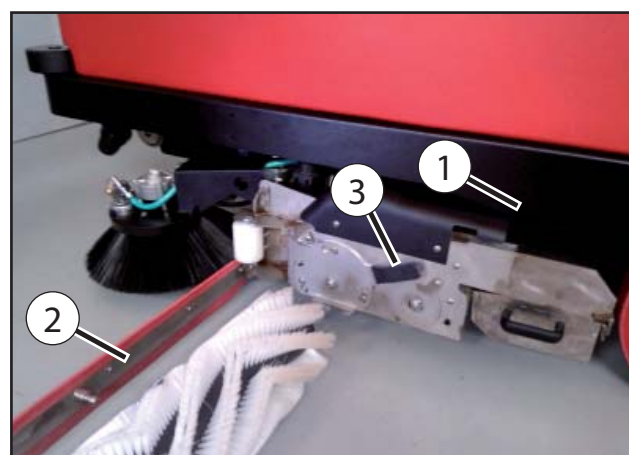
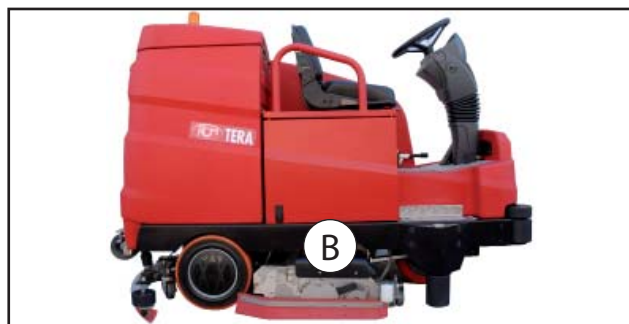

SQUEEGEE

Squeegee Assembly/Adjustment

For packaging requirements, the squeegee may be supplied disassembled from the machine and must be applied to the drive plate on the scrubber.

To assemble the squeegee, proceed as follows:

- » Match centring holes 1 up with slots 2.
- » Through levers 3, tighten squeegee 4 to plate 5.
- » Assemble vacuum pipe 6 on the squeegee.

To dry the floor perfectly, it is essential for the squeegee to be perfectly adjusted. The scrubber-drier uses a "CURVED" type squeegee, as seen in the figure.

This type of squeegee is able to efficiently collect the water towards the vacuum tube. However, it is sensitive to the parallelism with the ground.

For proper squeegee operation, you must find the ideal working angle with respect to the floor. Rear rubber blade 10 of the squeegee must work as vertical as possible and on its edge, as seen from the figure, so that the liquids are collected from the front side of the blade.

To achieve this, do the following:

- » Adjust nut 7, turning it clockwise (to tighten) to increase the squeegee tilt or anticlockwise (to loosen) to decrease the tilt.

Depending on the different types of floor to dry and the wear of the rubber squeegee blade, you must adjust its height from the ground. To do so, act in the following way:

- » Loosen nuts 8 and act on plates 13 to raise or lower the height from the ground and increase or decrease the load on the floor.
- » Once adjustment is complete, tighten nuts 8.

The same plates are also used to adjust the squeegee so that it works parallel to the ground.

For good blade duration, the pressure must be the minimum necessary, though still drying well.

Pay attention to the fact that, often, drying is adversely affected by a vacuum malfunction. In this case:

- » Thoroughly clean the vacuum hoses, the inputs, the filters and the squeegee itself.
- » Check vacuum motor operation.
- » Make sure that all the tank inspection hatches are tightly closed.

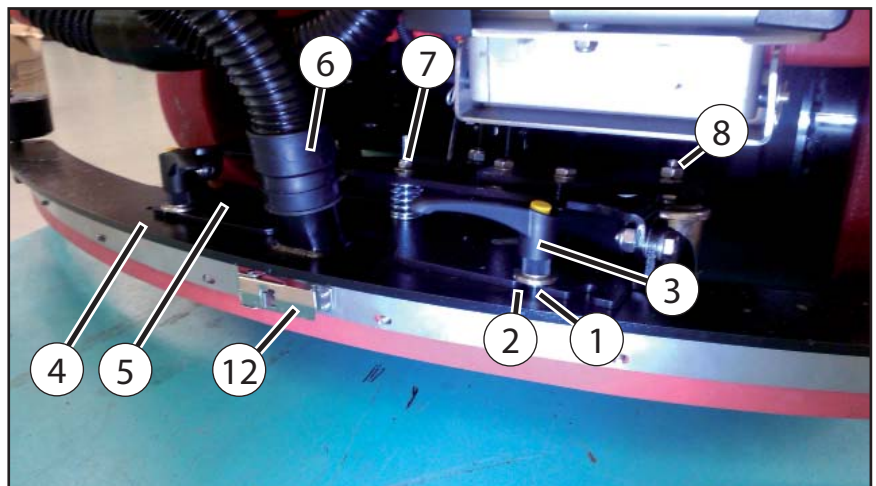
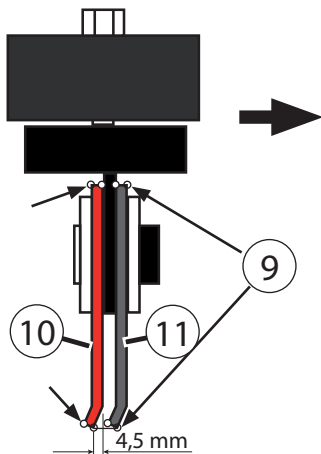
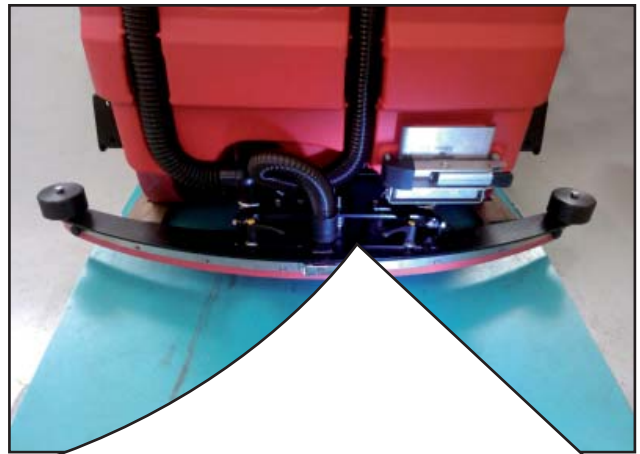
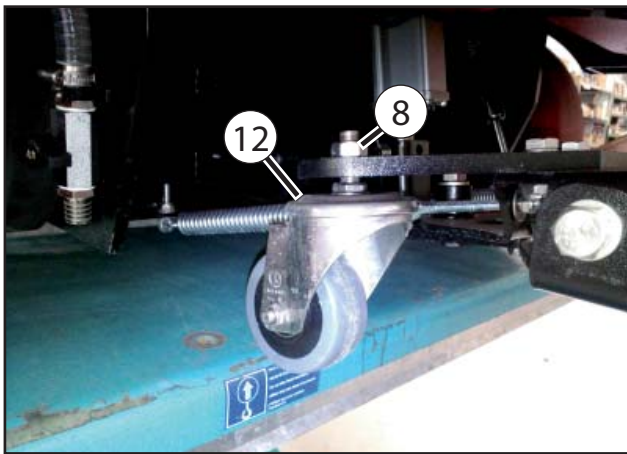

MAINTENANCE



Attention!

All maintenance operations must be performed with the machine off and the ignition key removed.

Cleaning the brushes and the squeegee

To clean properly with the brushes and dry well with the squeegee. Proceed as follows:

- » Make sure that the machine is off.
- » Make that the brush base is lifted off the ground.
- » Make sure the squeegee is lifted off the ground.

- » Remove the brushes, (see "BRUSHES- Replacing disc brushes and roller brushes") and wash them thoroughly with a jet of water.
- » Remove the squeegee, following the instructions given in the "Squeegee - Squeegee assembly and adjustment" chapter in reverse order. Thoroughly clean the inside of the squeegee and the rubber blade with a water jet.

To clean the rubber squeegee blades, you must remove them as described in "Changing the drying edge | replacing the rubber squeegee blades."

Changing the drying edge | replacing the rubber squeegee blades.

The function of the rubber blades is to retain the water used for washing, therefore, they must always be in perfect working order and replaced if broken or worn.

If the scrubber-drier is not vacuuming and drying perfectly. Change the drying edge if all the edges 9 (4 per blade) of rubber blades 10 and 11 described in the "SCRUBBER" chapter are worn, replace them, proceeding as follows:



Attention!

This operation is to be done at the end of work, using protective goggles and gloves.

Rear rubber blade:

- » Release lever 12 described in the "SCRUBBER" chapter, remove all the fixing elements and the corresponding blade mount.
- » Remove rear rubber blade 10 (see "SQUEEGEE").
- » Turn the rubber blade and assemble it on the squeegee. If the blade is completely worn, replace it.
- » Reassemble the blade mount and the fastening elements.

Front rubber blade:

- » Loosen the fixing elements.
- » Remove the blade mount.
- » Take off front blade 11 (see "SQUEEGEE").
- » Turn the blade and assemble it on the squeegee. If the blade is completely worn, replace it.
- » Reassemble the blade mount and the fastening elements.

Secure the REAR blade with its lever closing.

Tighten the fastening elements to secure the FRONT blade.

Proceed in adjusting the squeegee as described in the "Squeegee - Squeegee assembly and adjustment" chapter.



DRIVE SYSTEM

The scrubber-drier is moved by an electrical system composed of an in-wheel electric motor 1 located in front and an electronic control unit 2 which controls the operation of the in-wheel electric motor.

A steering column switch 11 described in the "Components" chapter equips the machine for forward or reverse. In addition, on the same steering column switch, there is a three position switch which is used to set the type of travel or working speed (See the "COMPONENTS and "STANDARD" OPERATING MODE chapters).

Then pushing on pedal 14 (see "COMPONENTS") controls the advancement of the scrubber-drier.



STEERING

Steering is operated by chain 1, which transmits motion from transmission pinion 2 to crown 3 on the front wheel. To adjust the play that can be generated on the steering wheel, loosen screws 4 and screw 5 to adjust chain tension.

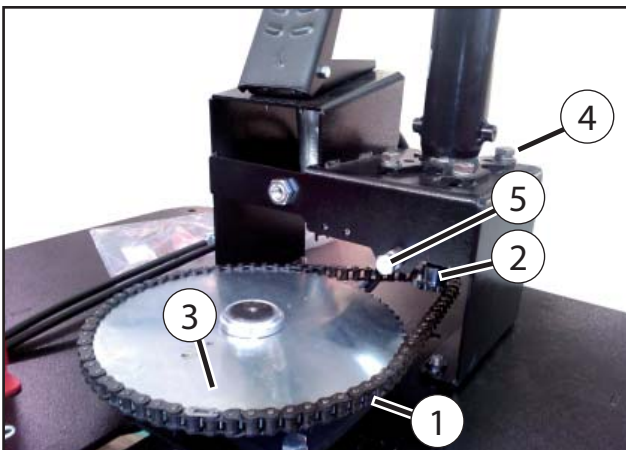

BRAKING (STANDARD)

The brakes are used to stop the moving scrubber and to keep it steady on inclined surfaces.

The TERA models are equipped with:

- » Hydraulic drum service brake on rear wheels using pedal 12. See "COMPONENTS"
- » Mechanical drum parking brake on rear wheels (TERA models equipped with parking brake lever 13. See "COMPONENTS").



Attention!

The parking brake lever is equipped with a safety microswitch which prevents the machine from being operated when the parking brake is engaged. Release the lever to restore normal machine operation.

- » Braking assisted by electric brake, (TERA models with front in-wheel electric motor **WITH** electric brake 1 (see photo below)).
- » Electric brake 1 is integrated in the drive system of front in-wheel electric motor 2, the brake keeps the machine braked when it is off or when it is on but stopped. The electric brake is equipped with a key 3 to unlock and manually move the machine when it is stopped. (for example: when the battery is missing). To carry out this operation, proceed as follows:

- Screw key 3 into its seat 4 on the electric brake and tighten it fully. During this operation, gently push the machine back and forth to facilitate releasing the electric brake and thus be able to manually move the machine.

- When finished, unscrew and remove the key to apply the brakes again and bring the machine back to safe conditions.

Store the key in a safe place and within reach in the event the machine has to be moved.

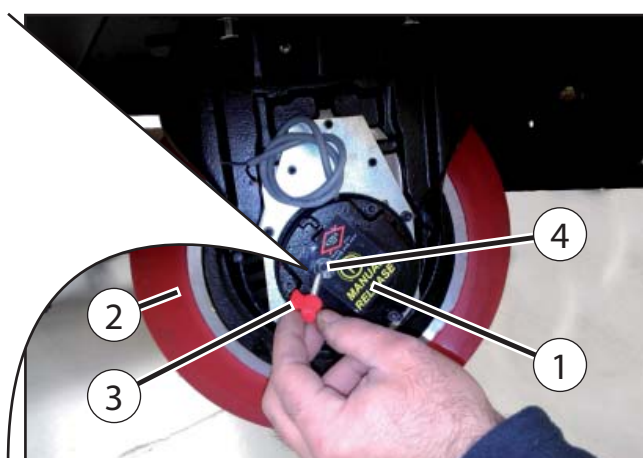

BRAKING SYSTEM WITH ELECTRO BRAKE ON REAR DRIVE WHEELS "OPTIONAL"

The machines with drive gear on rear wheels (optional) are equipped by an electro brake 5 and a blocking/unblocking lever on it.

- To keep braked the machine, put the lever 6 on position A.
- When the machine is required to move, the electrobrake can be unblocked (**the machine must be still immobilized**) by moving the lever "6" in the position "B".

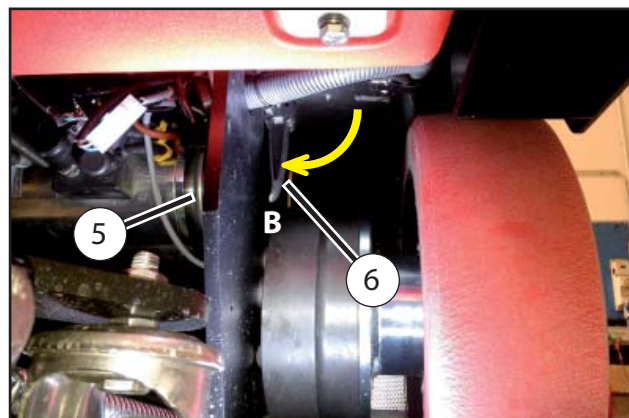
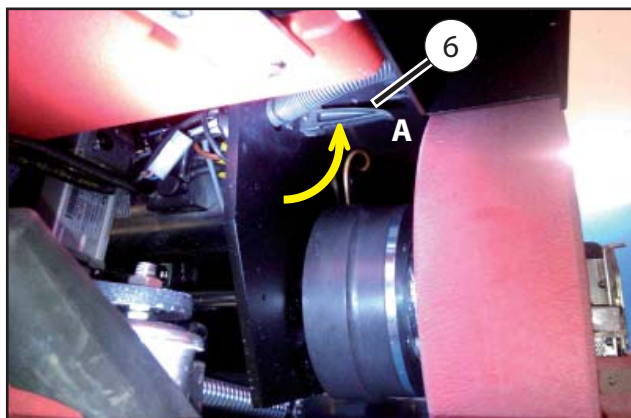

VACUUM MOTORS

They are used to vacuum the water collected from the squeegee.

The vacuum motors 1 vacuum by pressing the button described in the "COMPONENTS - POS.3" chapter, they must be checked daily.

For the control and maintenance of the vacuum motors, proceed as follows:

- » Stop the scrubber-drier and remove the ignition key from the dashboard.
- » Open cover 2 of vacuum motors 1.
- » Disconnect the connector of the vacuum motors.
- » Take out unit 3 support with motors.
- » To reassemble, proceed in the reverse order.

! Check brushes 3 of the vacuum motors for wear every six months, replacing them if required.

To check the brushes, proceed as follows:

- » Take off the cover of the vacuum motor.
- » Loosen the screws.
- » Take off the plastic brush supports.
- » Check them and replace them if necessary.
- » To reassemble, proceed in the reverse order.

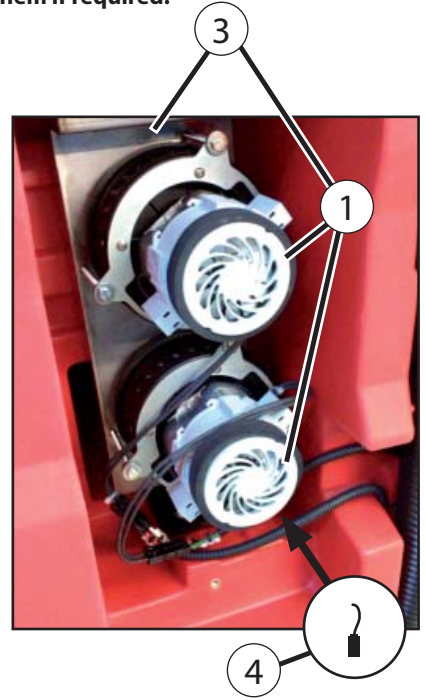

BATTERY

Checking the battery charge status.

As there is a direct relationship between the specific electrolyte weight and the battery charge status, measuring the specific electrolyte weight is assumed to be an efficient, proper check of the battery charge status. When the battery is charged and in normal conditions with the electrolyte at the right level, the electrolyte density will be about 1.260 (30° Bè) referring to 30° C. Instead, if the density is between 1.26 (30° Bè) and 1.20 (2 -Bè), the battery is running low, while if the density is less than 1.14 (18° Bè) the battery is completely flat.

Density measurement.

Measuring electrolyte density is the most important check on a battery. This measurement must be performed with the utmost care with a hydrometer, introducing it with a syringe and removing enough electrolyte to float the float. Make sure that the top of it does not touch the rubber pear or remain attached with the capillarity to the glass walls. If you were to measure the density after adding distilled water, you must expect the density to be homogeneous in all the liquid contained in the element.

Water top-up.

Add distilled water to each battery cell after charging the battery to bring the liquid level to 6mm above the plates. The operation will take place initially after each charge, afterwards topping up will take place less often depending on the experience of the person in charge, but never going over a week between one top up and the next.

Charge limits.

It is not necessary to recharge the battery if the density at the end of the working day has not dropped below 1.24 (28°Bè). The most common abuse found in the use of the battery for traction is overcharging. This factor alone, if applied continuously, can significantly shorten the duration. The maximum recommended temperature is 45 °C. If the temperature of the electrolyte increases by more than 10/12° C above ambient temperature, there can be an overcharge, regardless of the value of the temperature reached. If there is 5-10% charge remaining in the battery indicated on the dashboard display, travel and drying is allowed but not the rotation of the brushes or washing.

Premises for battery charging.

The gases which develop during the charging operation present dangers of explosion. It is, therefore, necessary to ensure that there is adequate ventilation for the battery during charging and that the terminal contacts are safe from any sparks. The premises where the accumulator batteries are charged must be well-ventilated, with temperatures that do not exceed 40/45 °C.

If there is not sufficient ventilation through the windows, special extraction ducts are provided, that must not lead to the flues. When necessary, the air exchange must be done quickly via fans.

Battery not in continuous service or inactive.

If the battery is not used continuously, it must be charged once a month, even if the specific weight measurements show high values. If the battery is idle for long periods of time, it must be stored in a cool, dry place. It must be fully charged once a month, until you notice a lively development of gas in all the elements and the voltage and specific weight readings remain constant for 3 - 4 hours. In any case, before putting a battery that has been idle for a long period into service, it needs to be charged and checked for proper electrolyte level.

BATTERY INSTALLATION

Install the battery in the dedicated compartment. Carefully check the battery before installing it to ensure the elements are not damaged. Never add electrolyte if the batteries have been idle for a week or longer.

The battery connections must be cleaned and a film of grease or Vaseline is needed on the terminals or connections. During transport, the battery may have lost some of its charge. If so, it must be charged before using the machine.

To install battery 1, proceed as follows:

- » Turn the closure of seat support 3 of and lift it (like in the photo).
- » Turn the closure of side cover 2 and open it.
- » Make sure tank 4 is empty and tilt it completely using the maximum extension of cable 5, like in the photo.
- » Insert the armoured battery in the compartment, hooking it via the two holes 6 and inserting it as shown.

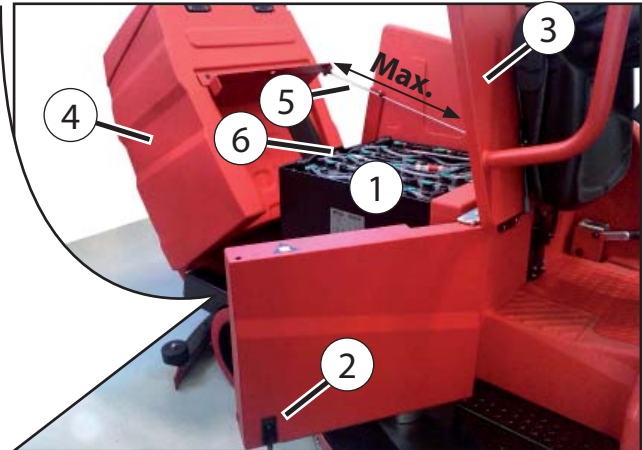
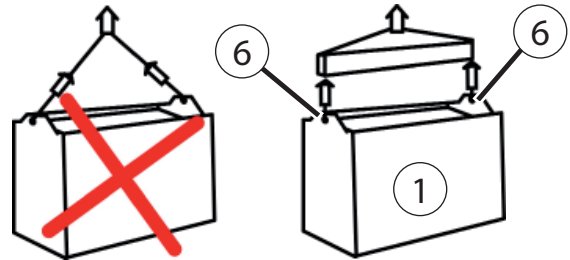

ELECTRICAL SYSTEM

To access the electrical system of the machine, open side door 1 unscrew screws 2. The electrical system consists of a traction control inverter 3 and an electronic control board 4 for the machine functions and the various electrical components described in the "WIRING DIAGRAM" chapter. In the event of a machine fault and/or malfunction, the inverter or the function board will show the alarm on the display with an acronym. (see "ALARMS" table).

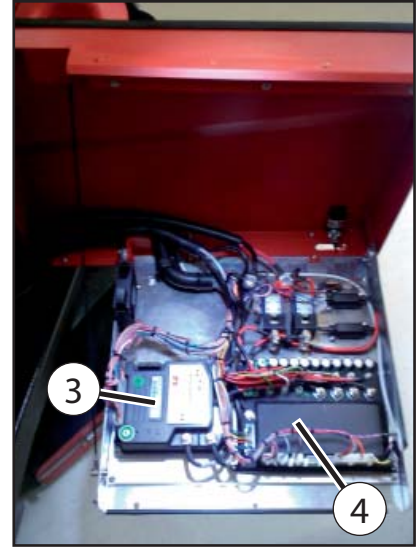
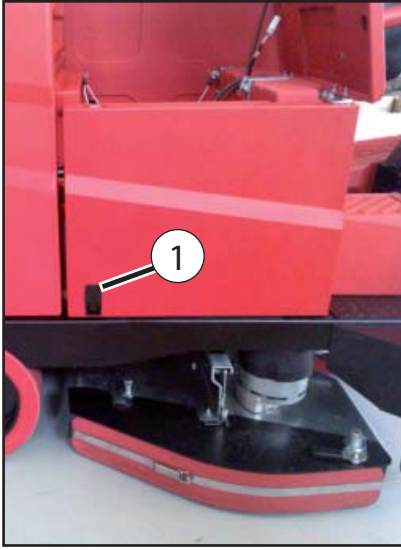

FUNCTION BOARD "ALARMS" (POS.3)

Alarm	Cause	Description and Solution
AL_1: Function brushes ammeter	Brush ammeter protection	Check the brush function mode of use. High brush motor working current detected.
AL_2: Function vacuum ammeter	Vacuum ammeter protection	Check the absorption of the vacuum motor. High brush motor working current detected.
AL_3: Function powerstage fail	Powerstage damaged	Brush or vacuum powerstage damaged: replace board.
AL_4: Function overcurrent	Overcurrent on brush or vacuum outputs	Overcurrent detected on brush or vacuum motor output: Check motor connections and status.
AL_5: Function overtemperature	Thermal protection on brush/vacuum stage	Brush and vacuum powerstage overheating: check absorptions.
AL_6: Function Act1: endsw fail	Fault on brush actuator limit switch reading	Fault in the limit switch configuration. Check brush actuator limit switch connections and status.
AL_8: Function Act1: timeout	Brush actuator: final position not reached	Position of brush actuator not reached in the maximum time allowed. Check actuator connections and/or for any mechanical obstructions.
AL_9: Function Act2: timeout	Squeegee actuator: final position not reached	Squeegee actuator position not reached in the maximum time allowed. Check actuator connections and/or for any mechanical obstructions.
AL_20: General EEprom fail	Internal memory reading error	Replace board.
AL_21: General Key-off failure	Wrong key sequence.	Rebound detected on the key signal: Check connections and key contact status.
AL_22: General main rele fail	General relay damaged or vacuum motor disconnected	The general relay on the board seems damaged: replace board. Check vacuum motor connections and operation.
AL_23: General overvoltage	Overvoltage.	Overvoltage detected on the function board. Check battery connections.
AL_24: Traction batt connection	Battery not connected to the function board	Check the traction function mode of use. High traction motor working current detected.
AL_25: General keyboard fail	No dashboard-functions communication	Check connections between keyboard and functions.
AL_26: General RX-TX traction	No traction-functions communication	Check connections between traction board and functions.

INVERTER TRACTION "ALARMS" (POS.2)

Alarm	Cause	Description and Solution
AL TR 8	WATCH DOG	Problem in the WATCHDOG electric circuit, which loses the ability to activate or inhibit system power. If motor phase continuity is verified, the problem is related to the system logic (inverter) which must, therefore, be replaced.
AL TR 13	EEPROM KO	Problem with parameter memory. Try running a CLEAR EEPROM to restore it. If the operation is unsuccessful, replace the damaged EEPROM.
AL TR 17	LOGIC FAILURE #3	Failure of hardware circuit that supervises and protects the system from overcurrent peaks by opening the three-phase bridge. The problem is related to the system logic (inverter), which must, therefore, be replaced.
AL TR 18	LOGIC FAILURE #2	Failure of hardware circuit that guarantees sine wave timing. The problem is related to the system logic (inverter), which must, therefore, be replaced.
AL TR 19	LOGIC FAILURE #1	Overvoltage or undervoltage signalled. Trips when the battery charge is excessively different (approx. + or - 20%) from the nominal value. In this case, you must identify and prevent the cause of the problem (generally, overvoltage is when regeneration is too high, undervoltage is when the battery is too low). It is not related to the system.
AL TR 30	VMN LOW	Diagnosis at start-up that trips when the measured phase voltage is too low compared to the expected value. Make sure the motor power cables are securely connected (a disconnected or poorly contacted phase causes errors). If the power connections are in order, then the damage is likely related to the system power section and thus, it must be replaced.
AL TR 31	VMN HIGH	Similar to VMN LOW, this diagnosis trips when the measured phase voltage is too high compared to the expected value. Make sure the motor power cables are securely connected, intact and not shorted. If the power connections are in order, then the problem can be attributed to the system power section and thus, it must be replaced.
AL TR 37	CONTACTOR CLOSED	The general contactor power contact is closed even if its reel is not piloted. Make sure the contactor has not got stuck or damaged and in the event, replace it.
AL TR 38	CONTACTOR OPEN	The general contactor power contact is closed even if its reel is being piloted. Make sure the reel wiring is not interrupted, poorly wired or damaged in general. Replace it if necessary.
AL TR 49	I=0 EVER	When the motor is in movement, the system current sensor sees a zero piloting current. The sensor, therefore, is damaged and the control must be replaced.
AL TR 53	STDBY I HIGH	Unlike the previous point, the piloting current is always high, even when it should be zero. If the error persists, the control is damaged and must be replaced.
AL TR 60	CAPACITOR CHARGE	During the pre-charge stage (the one between switching on the key and closing the general contactor), the voltage at the pre-charge condenser heads does not reach full capacity. Make sure there are no inductive charges parallel to the condensers and that no problems intervene in the motor or system power section.
AL TR 61	HIGH TEMPERATURE	Warning indicating that the control temperature has exceeded the critical threshold (approximately 72°). The machine is stopped to allow the control to cool down.
AL TR 65	MOTOR TEMPERATURE	Warning indicating that the motor temperature has exceeded the critical threshold (depends on the motor). The machine is stopped to allow the motor to cool down.
AL TR 75	CONTACTOR DRIVER	The line contact reel power voltage is lower than expected. Make sure there the general contactor reel is not shorted. If the error persists, the damage can be attributed to the system piloting circuit, which must, therefore, be replaced.
AL TR 76	COIL SHORTED	This is a diagnosis of the general contactor. If the general contactor reel is excited at start-up despite not being commanded, then the general contactor opens and signals an error.
AL TR 78	VACC NOT OK	Trips 20" after the accelerator pedal is pressed if no gear is put in (that is, the pedal is pressed uselessly, in neutral gear or without seat). Make sure the wire is not shorted.
AL TR 79	INCORRECT START	Warning indicating an incorrect machine start-up sequence. Repeat the correct sequence: Sit down properly + Put into Gear + Press accelerator pedal.
AL TR 80	FWD+BACK	Warning signalling that the forward and backward gear have been requested simultaneously.
AL TR 86	PEDAL WIRE KO	Accelerator potentiometer central unit interrupted. Check the accelerator pedal CPOT (potentiometer central unit).
AL TR 250	SENS MOTOR TEMP. KO	Motor temperature probe interrupted. You must make sure the wiring is not interrupted and, if necessary, replace the motor thermal probe. This warning can appear both during testing and during machine use.
AL TR 251	HANDBRAKE	Warning indicating that the handbrake is engaged. This alarm does not impede operation; simply release the lever before starting up the run sequence (sit down properly + put into gear + press accelerator pedal).
AL TR 253	ENCODER ERROR	Motor revolution sensor (encoder) interrupted. You must make sure the wiring is not interrupted and, if necessary, replace the motor sensor. This warning can appear both in testing and during machine use. The system is unable to retroactively check whether the set-point is consistent with machine behaviour and, therefore, inhibits vehicle operation.
AL TR 254	AUX OUTPUT KO	Failure of the drive piloting the auxiliary output, that is, the magnetic parking brake. Make sure there are no reel wiring problems that cause a false positive. If the brake is in order, replace the inverter.

NB: For information on the alarms, contact the Assistance Service.

ELECTRICAL SYSTEM

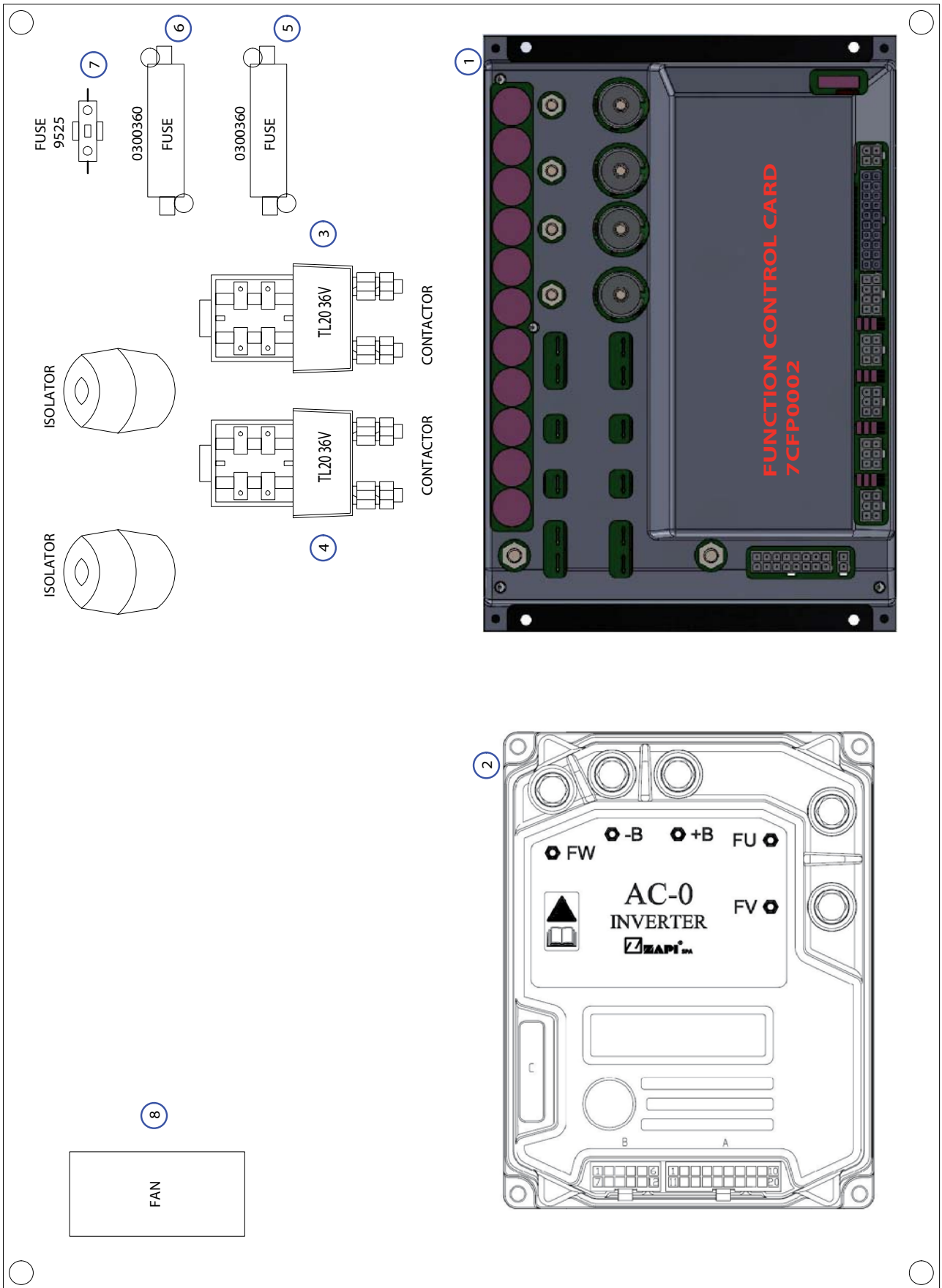

(continue to page follows)

ELECTRICAL SYSTEM

FUNCTION CONTROL CARD
7CFP0002

1

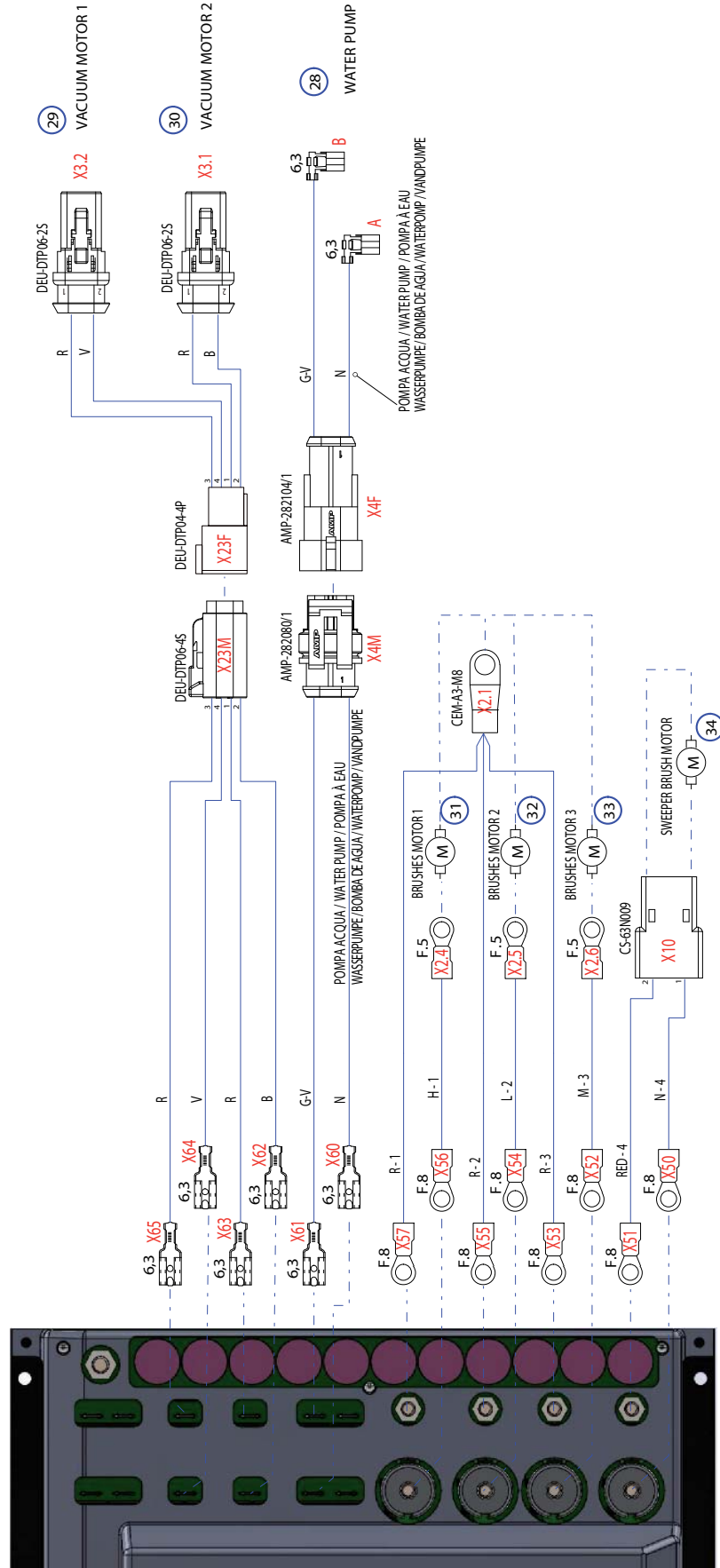

(continue to page follows)

ELECTRICAL SYSTEM

FUNCTION CONTROL CARD
7CFP0002

1

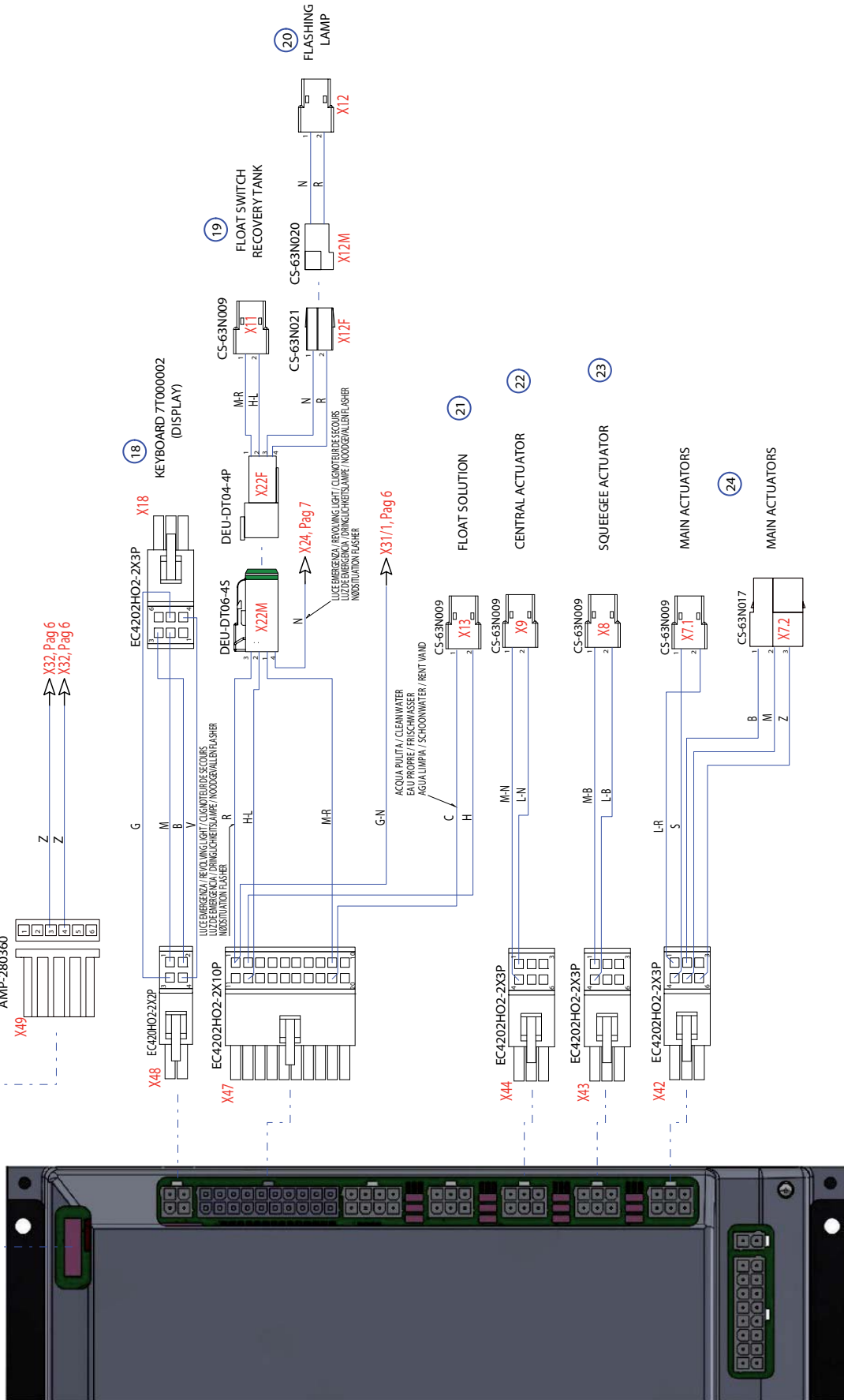

(continue to page follows)

FUNCTION CONTROL CARD
7CFP0002

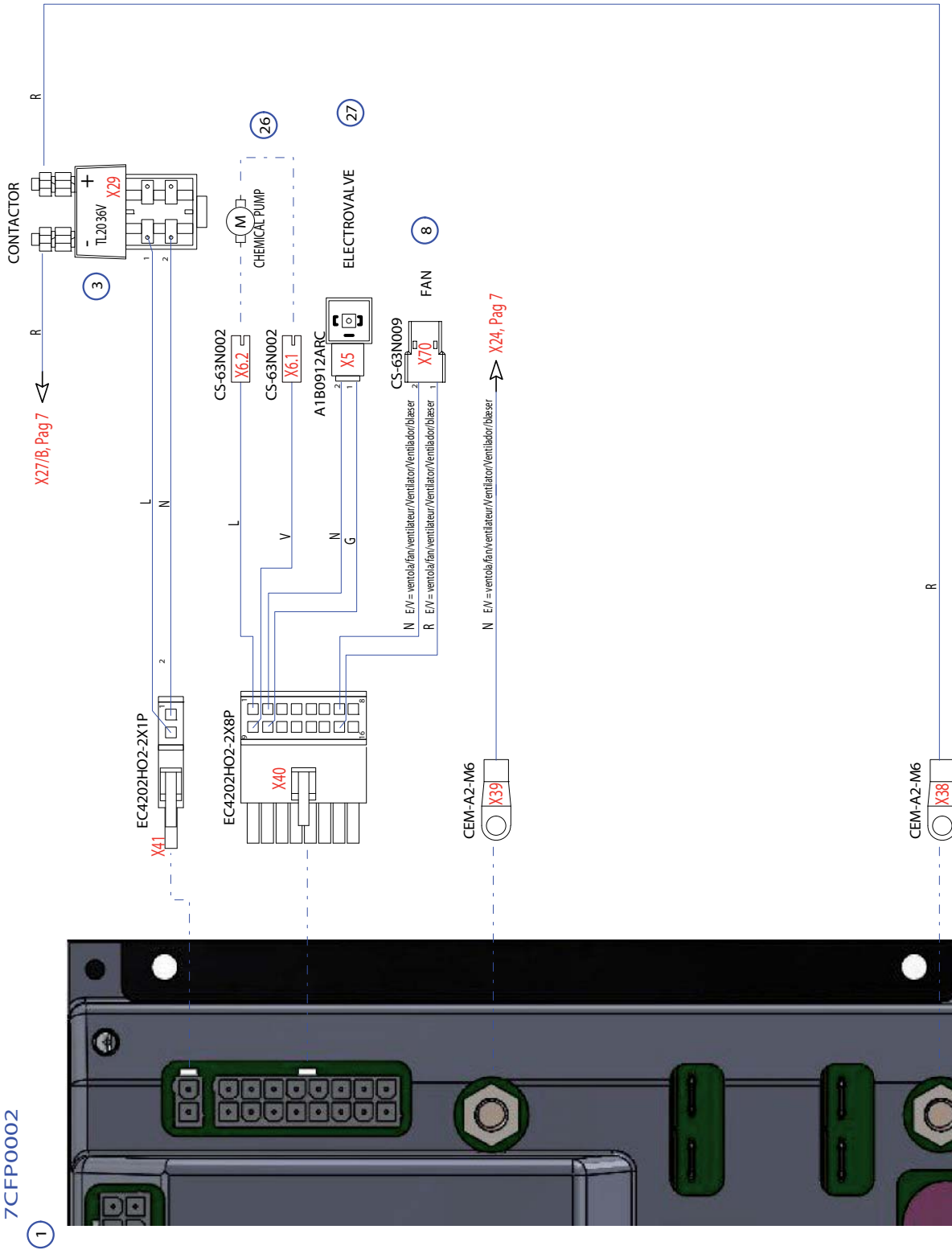

(continue to page follows)



ELECTRICAL SYSTEM

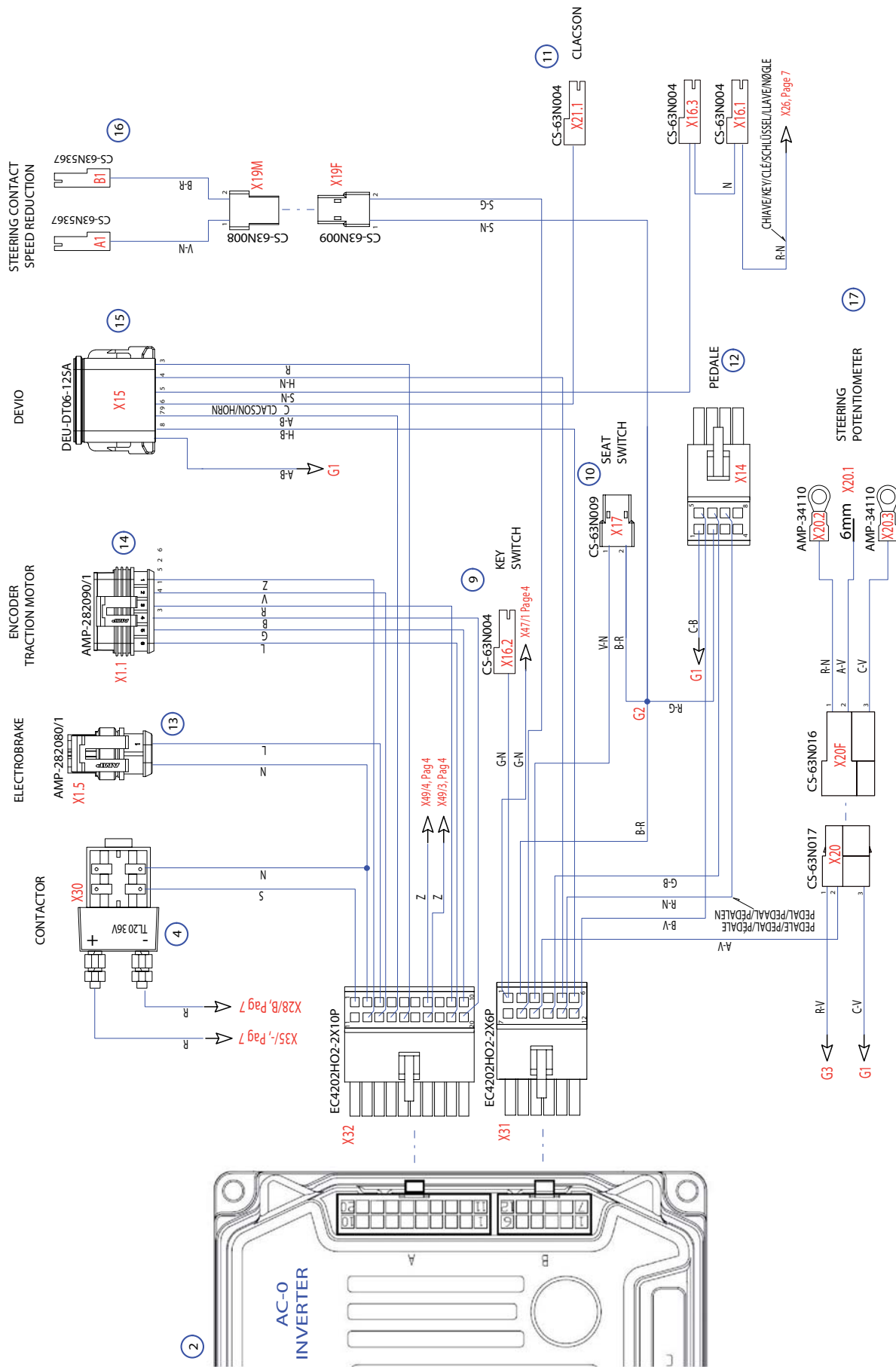

(continue to page follows)

ELECTRICAL SYSTEM

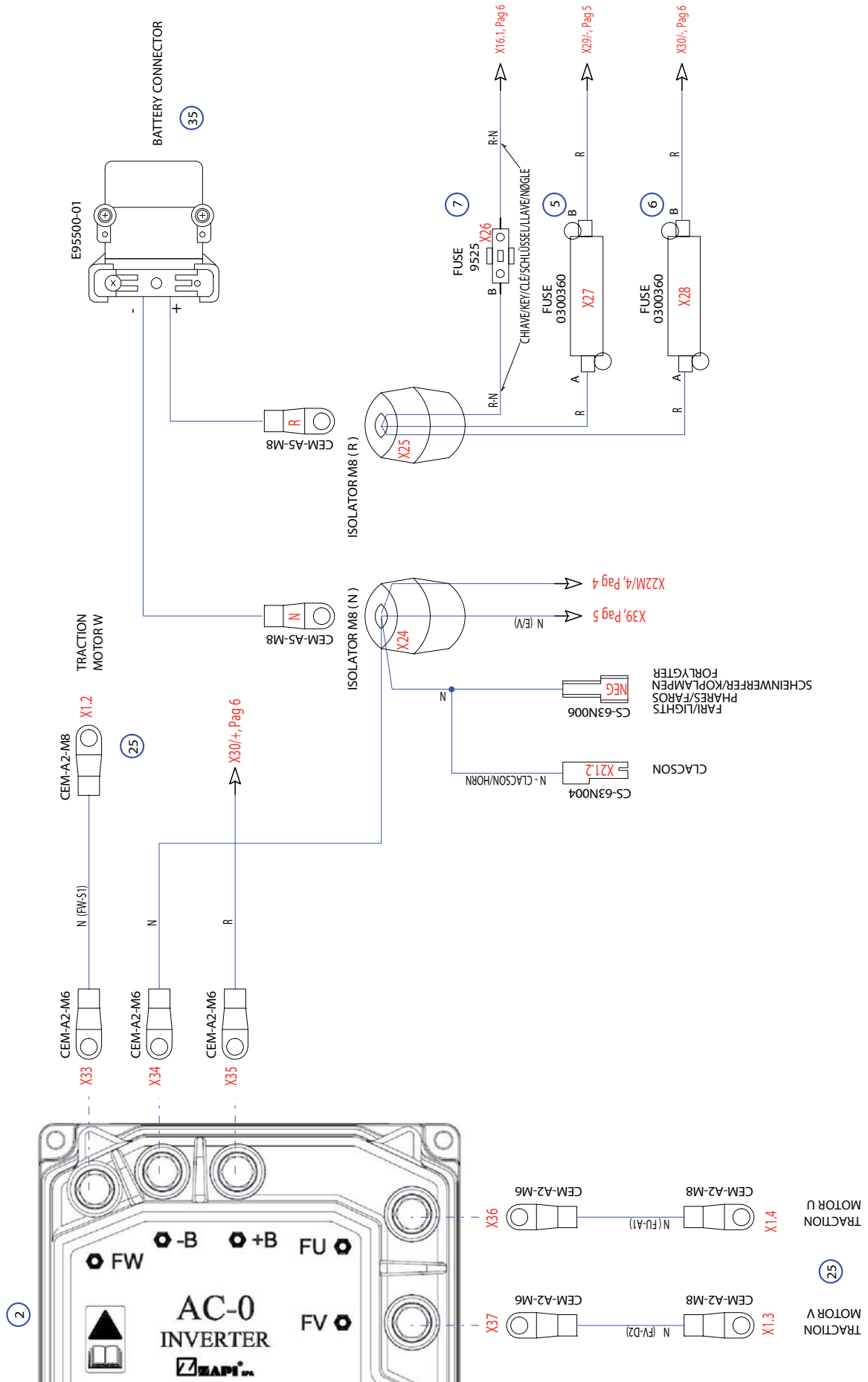

ELECTRICAL SYSTEM DESCRIPTIONS

- 1) Electronic control functions 7cfp0002
- 2) Electronic control traction
- 3) Contactor input control board functions
- 4) Contactor input control board traction
- 5) Fuse input control board functions
- 6) Fuse input control board traction
- 7) Fuse key
- 8) Fan
- 9) Key switch
- 10) Seat switch
- 11) Horn
- 12) Accelerator pedal
- 13) Electrobrake
- 14) Traction motor encoder
- 15) Devio
- 16) Steering contact speed reduction
- 17) Potentiometer steering
- 18) Keyboard display
- 19) Recovery tank float
- 20) Revolving light
- 21) Solution float tank
- 22) Central actuator
- 23) Squeegee actuator
- 24) Main actuator
- 25) Traction motor
- 26) Chemical pump
- 27) Electrovalve
- 28) Water pump
- 29) Vacuum motor 1
- 30) Vacuum motor 2
- 31) Brushes motor 1
- 32) Brushes motor 2
- 33) Brushes motor 3
- 34) Sweeper brush motor
- 35) Battery connector

Wiring colors

A	Light Blue
B	White
C	Orange
G	Yellow
H	Grey
L	Blue
M	Brown
N	Black
R	Red
S	Pink
V	Green
Z	Violet



PERIODIC CONTROL, MAINTENANCE AND SAFETY CHECKS

- 1) The machine must be inspected by a qualified technician who checks its safety conditions or for any damage or defects in the following cases:
 - » Before commissioning.
 - » After modifications and repairs.
 - » Periodically, in accordance with the table "Periodic maintenance and control - page 62".
- 2) Every six months, check the efficiency of the safety devices; the inspection must be performed by qualified personnel trained for this purpose. To ensure the efficiency of the safety devices, the machine must be serviced by an authorised workshop every 5 years.
- 3) The person responsible for machine management must perform an annual check on its status. This check must establish whether the machine always corresponds to the prescribed technical safety provisions. After the check, a label must be applied to the machine which testifies that testing has taken place.

MAINTENANCE AND CONTROL OPERATIONS TABLE		to be carried out at:		
		8h	40h	200h
1	Clean the recovery tank	√		
2	Clean the vacuum motor filter	√		
3	Check the clean water tank filter	√		
4	Check the cleanliness of the vacuum hoses and the squeegee	√		
5	Check the cleanliness of the vacuum filter (6- page 19)	See "Water loading draining"		
6	Check the cleanliness of the waste collection container (7- page 19)			
7	Check the status of the brushes		√	
8	Check the status of the rubber squeegee blades		√	
9	Put a few drops of oil on the steering column chain		√	
10	Check the solenoid valve for water supply (washing solution)		√	
11	Every six months, check the status of the brushes of each motor			√
12	If there is any optional equipment, check its cleanliness and operation	√		

SAFETY INFORMATION



1) Cleaning:

In the cleaning and washing operations of the machine, aggressive detergents, acids, etc., must be used with caution. Follow the instructions of the detergent manufacturer and, if required, use protective clothing (overalls, gloves, goggles, etc.). Refer to the EC directive on the subject.

2) Explosive atmosphere:

The machine is not built to work in environments with the possibility of existing gas, dust or fumes. As such, using it in explosive atmospheres is PROHIBITED.

3) Disposal of toxic substances:

To dispose of the collected material, machine filters and exhausted material such as batteries, motor oil, etc., follow the laws in force regarding their disposal and treatment.

MACHINE DEMOLITION



The machine must be brought to a licensed collector who will see to disposing of it properly. In particular oils, filters and batteries. The ABS and metal parts can be recycled as secondary raw materials. The rubber hoses and gaskets, as well as the plastic and common fibreglass and plastic must be separately conferred to municipal cleaning companies.



The packaging of the machine is composed of recyclable material. Dispose of it by bringing it to special recycling centres.

TROUBLESHOOTING

Problem	Cause	Solution
the squeegee does not dry	rubber squeegee blades worn	replace the blades
	squeegee clogged	clean the squeegee
	a foreign object has become wedged in the squeegee.	remove the foreign object
	vacuum hose clogged	clean the hose
	squeegee poorly adjusted	adjust the tilt angle (see "SQUEEGEE")
	water drain hose cap open	close tightly
	vacuum motor burned out	replace the motor
	vacuum motor brushes worn.	replace the brushes.
	squeegee not lowered at start-up. faulty actuator	replace the actuator
vacuum motor filter clogged.	clean the filter (see "VACUUM MOTORS").	
the detergent solution does not come down evenly on the brushes.	water supply hoses on the brushes clogged.	clean the clogged hose
	clogged solution filter	clean the filter
the detergent solution does not come down or only a small amount comes out on the brushes	water supply hoses on the brushes clogged.	clean the clogged hose
	the solution opening valve does not open	check the valve
	clogged solution filter	clean the filter
	closing electromagnet blocked or hose crushed.	replace the electromagnet or restore or replace the hose
the machine does not clean well	no water in the tank.	fill the water tank.
	brushes badly worn	replace brushes
the machine does not start	poor brush pressure on the floor	adjust pressure
	the main insertion key has not been inserted (see "COMPONENTS - POS.10")	turn the key clockwise
	the batteries are low	check the charge and charge them, if necessary
	blown fuse	check the fuse and replace it, if necessary attention! never use fuses of a higher value, you risk causing damage to the system. if the fuses blow repeatedly, this means the machine has a defect: contact an authorised service centre.
	safety micro-switch on the parking brake broken. (TERA models with lever parking brake)	replace the micro-switch
< continued on the next page >		



TROUBLESHOOTING		
Problem	Cause	Solution
the machine does not start or it stops suddenly.	motors under enough stress to trip the thermal magnetic protection	wait for about a minute and then repeat the start-up procedure.
	batteries low	charge the batteries
	fault, alarm shown on the display.	see "ALARMS" table
the machine does not move forward or in reverse.	pedalboard connection unplugged	restore the contact.
the vacuum motor switches off and does not start up.	the full recovery tank float has cut power to the vacuum motors	immediately switch off the vacuum motors using button 3 (see "COMPONENTS"). empty the recovery tank Restart the machine.
	float blocked by impurities	unblock and clean the float from impurities. to do this, remove the right vacuum motor to make the float accessible.
the machine does not move	parking brake engaged (TERA models with lever parking brake)	release the parking brake
	Electric brake	Check electric brake operation
water leak when machine is stopped	feed tube broken	fully close the valve and replace the tube
the brush unit does not lift or lower	board main fuse	replace
	actuator does not receive power	check
	actuator motor broken	replace
	actuator micro faulty	replace
	board	replace
the squeegee does not lift or lower	board main fuse	replace
	actuator	replace
	board	replace

